

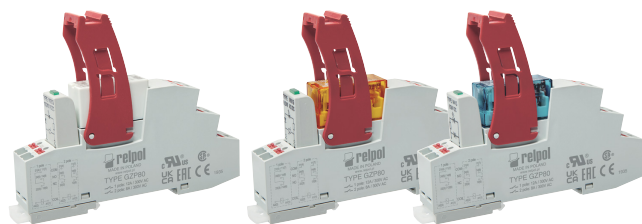



# PI85 with socket Push-in GZP80 interface relays with Push-in terminals

RM85 + GZP80

RM85 (AC) ① + GZP80

RM85 (DC) ① + GZP80



- Interface relay **PI85 with socket GZP80**, designed for continuous operation\*, consists of: electromagnetic relay **RM85** (standard white or option transparent: AC orange, DC blue ①), grey plug-in socket **GZP80** (flammability class V-0), signalling / protecting module type **M...**, retainer / retractor clip **GZP80-0400** (plastic)
- 35 mm rail mount acc. to EN 60715 or on panel mounting with one M3 screw
- May be linked with interconnection strips type **ZGZP...**
- Recognitions, certifications, directives\*\*: recognitions RM85, RoHS,    

## Contact data

Number and type of contacts		1 CO
Contact material		<b>AgNi</b> , AgNi/Au hard gold plating, AgSnO <sub>2</sub>
Rated / max. switching voltage	AC	250 V / 300 V
Min. switching voltage		5 V AgNi, 5 V AgNi/Au hard gold plating, 10 V AgSnO <sub>2</sub>
Rated load (capacity)	AC1	16 A / 250 V AC ②
	AC15	3 A / 120 V 1,5 A / 240 V (B300)
	DC1	16 A / 24 V DC (see Fig. 3)
	DC13	0,22 A / 120 V 0,1 A / 250 V (R300)
Motor load	acc. to UL 508	1/2 HP 240 V AC, 4,9 FLA, single-phase motor ③
	AC3 acc. to IEC 60947-4-1	0,5 kW 240 V AC, single-phase motor
Min. switching current		5 mA AgNi, 2 mA AgNi/Au hard gold plating, 10 mA AgSnO <sub>2</sub>
Max. make current		30 A
Rated current		16 A
Max. breaking capacity	AC1	4 000 VA
Min. breaking capacity		0,3 W AgNi, 0,05 W AgNi/Au hard gold plating, 1 W AgSnO <sub>2</sub>
Contact resistance		≤ 100 mΩ
Max. operating frequency	• at rated load AC1 • no load	600 cycles/hour 72 000 cycles/hour

## Coil data

Rated voltage	50/60 Hz AC	12, <b>24</b> , 48, 115, 120, <b>230</b> V
	DC	12, <b>24</b> , 48, 110 V
Must release voltage		AC: ≥ 0,15 U <sub>n</sub> DC: ≥ 0,1 U <sub>n</sub>
Operating range of supply voltage		see Tables 1, 2 and Fig. 4, 5
Rated power consumption	AC	0,75 VA
	DC	0,4 ... 0,48 W

## Insulation according to EN 60664-1

Insulation rated voltage		250 V AC
Rated surge voltage		4 000 V 1,2 / 50 μs
Overvoltage category		III
Insulation pollution degree		3
Dielectric strength	• between coil and contacts • contact clearance	5 000 V AC type of insulation: reinforced 1 000 V AC type of clearance: micro-disconnection
Contact - coil distance	• clearance • creepage	≥ 10 mm ≥ 10 mm

## General data

Operating / release time (typical values)		7 ms / 3 ms
Electrical life	• resistive AC1 • cosφ • DC L/R=40 ms	> 0,7 x 10 <sup>5</sup> 16 A, 250 V AC see Fig. 2 > 10 <sup>5</sup> 0,15 A, 220 V DC
Mechanical life (cycles)		> 3 x 10 <sup>7</sup>
Dimensions (L x W x H)		97 x 15,9 x 75,8 mm
Weight		65 g
Ambient temperature	• storage (non-condensation and/or icing) • operating	-40...+85 °C coil AC: -40...+70 °C coil DC: -40...+85 °C -20...+70 °C ①
Cover protection category		IP 20 EN 60529
Environmental protection		RM85: RTII GZP80: RT0 EN 61810-1
Shock resistance		30 g
Vibration resistance		10 g 10...150 Hz

The data in bold type relate to the standard versions of the relays. \*The relays are designed for continuous operation while maintaining the parameters declared in the data sheet. \*\*The cULus certification covers the certifications of the interface kit components, i.e. socket and relay. ① Special versions - relays in transparent cover, operating temperature -20...+70 °C. See "Ordering codes". ② Loads above 12 A require bridging pairs of Push-in terminals: 11 with 21, 12 with 22, 14 with 24 - see page 2. ③ For single phase motors for 110-120 V AC do not use motors with higher FLA than given for 240 V AC.

# PI85 with socket Push-in GZP80 interface relays with Push-in terminals

## Dimensions

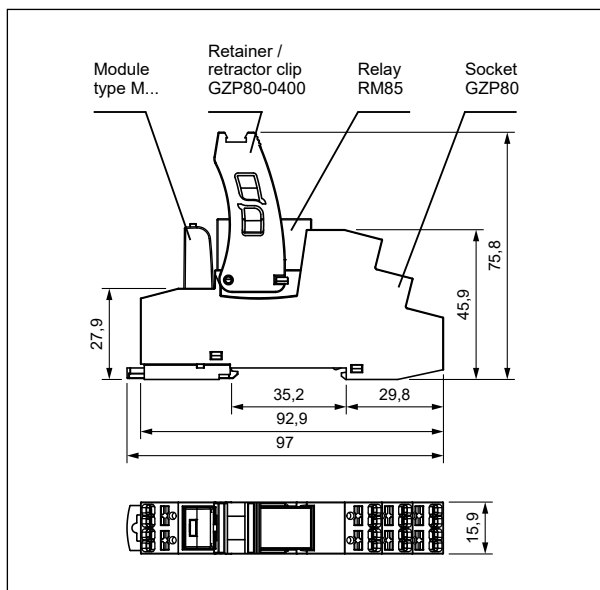

## Connection diagrams (Push-in terminals side view)

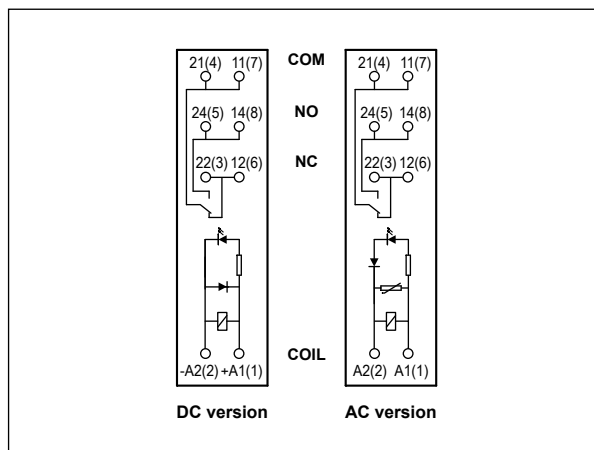

## Wire connection

The drawings present inserting wire into the Push-in terminal and removing wire using the button releasing a clamp (assembly without tools).

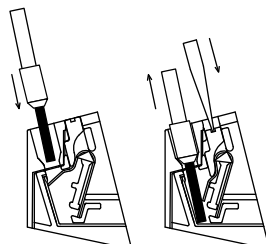

## Connection of GZP80 socket

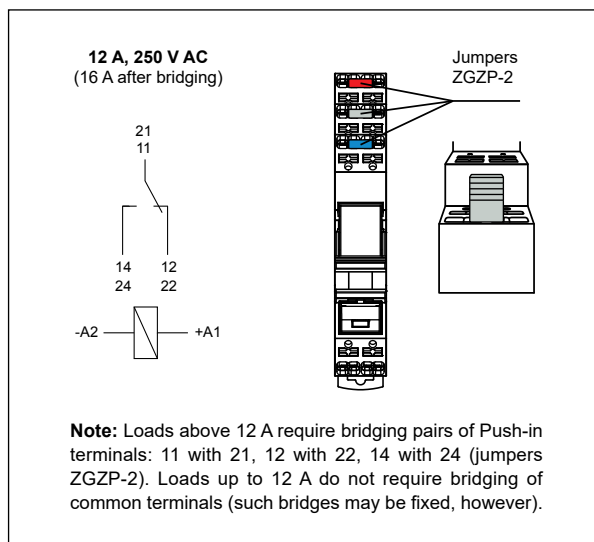

## Connecting accessories

- see page 6



ZGZP80-8 GY grey  
ZGZP80-8 BK black  
ZGZP80-8 RD red  
ZGZP80-8 BE blue



ZGZP80-2 GY grey  
ZGZP80-2 BK black  
ZGZP80-2 RD red  
ZGZP80-2 BE blue



ZGZP-2 GY grey  
ZGZP-2 BK black  
ZGZP-2 RD red  
ZGZP-2 BE blue

**Strips 8-poles ZGZP80-8:** unlimited possibilities of connection configurations (bridging of: A1, A2, A1 & A2 together), fast, safe and easy bridging of signals on the coil.

**Strips 2-poles ZGZP80-2:** free bridging of common input signals and terminals on the contact side, creating parallel connections of outputs in redundancy systems.

**Jumpers 2-poles ZGZP-2:** parallel connections of neighbouring poles in one socket GZP80 or GZP4 without use additional wiring, increasing the load capacity from 12 A to 16 A (PI85, PI85P).

**Electrical life at AC resistive load.**  
Switching frequency: 600 cycles/hour

Fig. 1

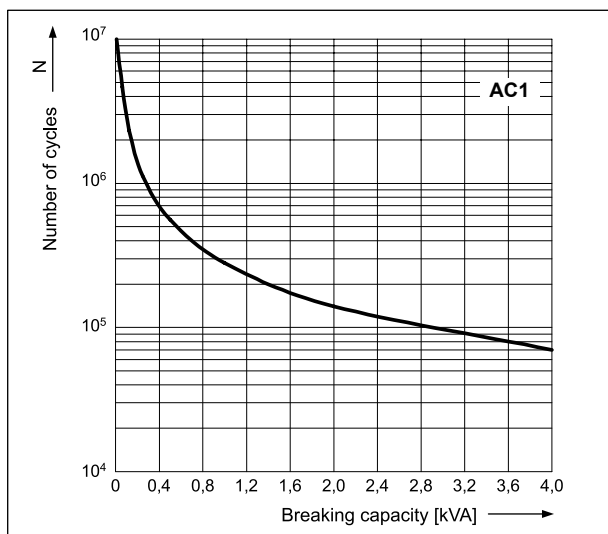

**Electrical life reduction factor at AC inductive load**

Fig. 2

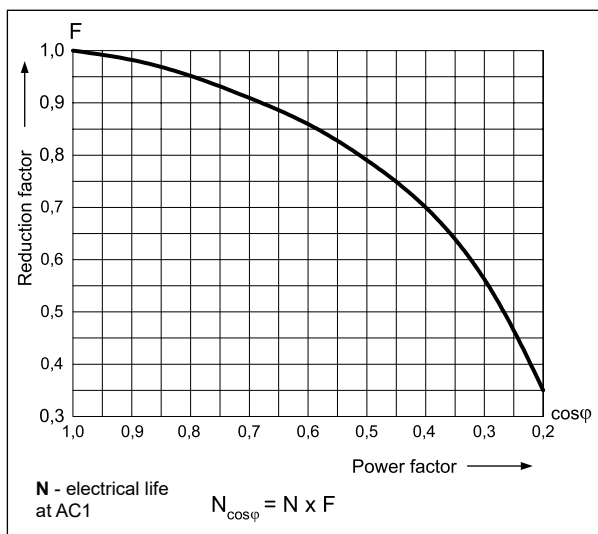

**Max. DC resistive load breaking capacity**

Fig. 3

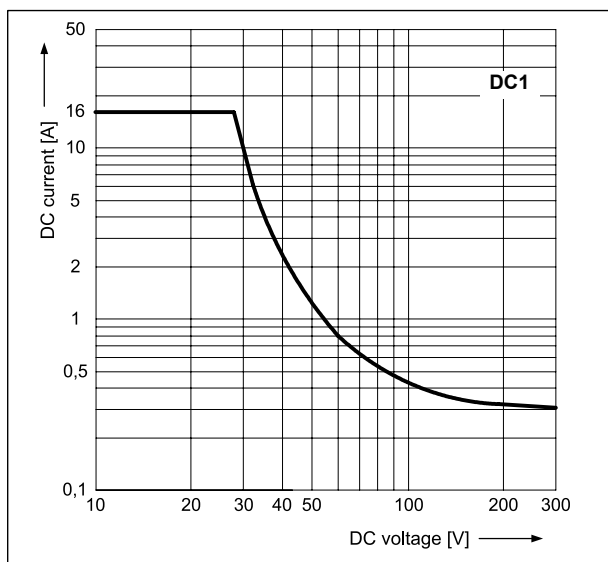

**Coil operating range - DC**

Fig. 4

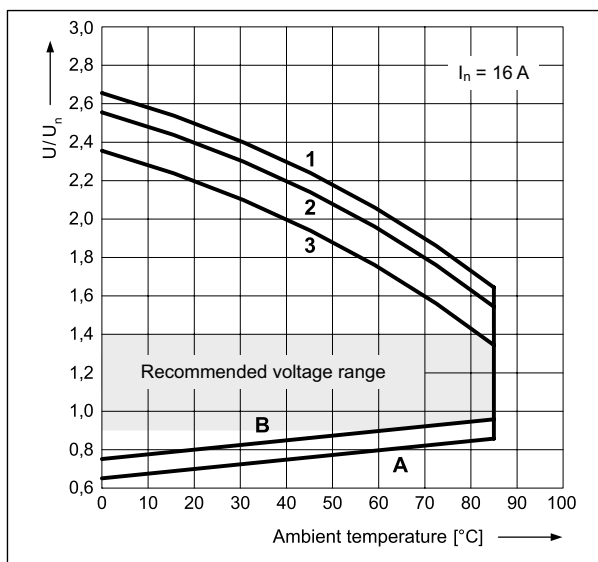

**Coil operating range - AC 50 Hz**

Fig. 5

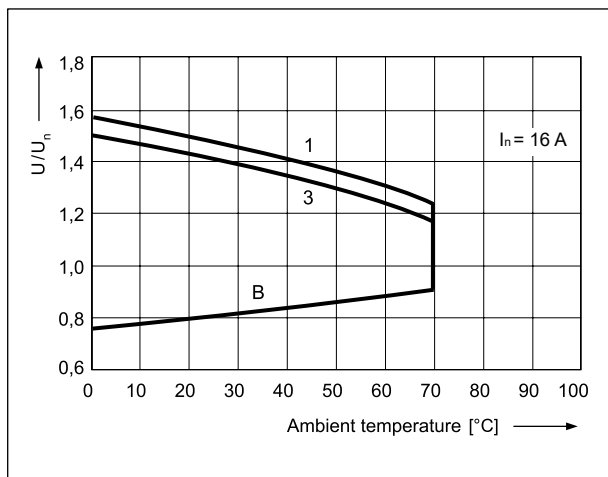

**Description of Fig. 4 and 5**

Using voltage other than the rated coil voltage may reduce the electrical life of the relay. Figure 4 shows the permissible voltage range for the relay coil, higher coil supply voltages may damage the coil insulation.

**A** - relations between make voltage and ambient temperature at no load on contacts. Coil temperature and ambient temperature are equal before coil energizing. Make voltage is not higher than the value read on Y axis (multiplication of rated voltage).

**B** - relations between make voltage and ambient temperature after initial coil heating up with 1,1 U<sub>n</sub> at continues load of I<sub>n</sub> on contacts. Make voltage is not higher than the value read on Y axis (multiplication of rated voltage).

**1, 2, 3** - values on Y axis represent allowed overvoltage on coil at certain ambient temperature and contact load:

- 1** - no load
- 2** - 50% of rated load in AC1 category
- 3** - rated load in AC1 category

# PI85 with socket Push-in GZP80 interface relays with Push-in terminals

## Mounting

Relays **PI85 with socket GZP80** are designed for direct mounting on 35 mm rail mount acc. to EN 60715 or on panel mounting with one M3 screw. **Connections:** max. cross section of the cables: 2 x 1,5 mm<sup>2</sup> (ferrules without insulation), 2 x 1 mm<sup>2</sup> (ferrules with insulation), stripping length: 8...10 mm.

Plug-in sockets **GZP80** (flammability class V-0) may be linked with interconnection strips type **ZGZP...** Strip **ZGZP80-8** bridges common input signals, maximum permissible current is 10 A / 250 V AC, possibility of connection of 8 sockets. Strip **ZGZP80-2** bridges common input or output signals, possibility of connection of 2+n sockets. Jumper **ZGZP-2** bridges the neighboring poles of single socket **GZP80**. Colours of strips: **ZGZP...GY** grey, **ZGZP...BK** black, **ZGZP...RD** red, **ZGZP...BE** blue (see page 6).

Description plates **MP15**, snap into tall marker groove, compatible with the standard for DIN rail terminal blocks, should be ordered separately.



**Terminals directed to wiring ducts:** esthetic cabling management, easier content reading from markers on wires.

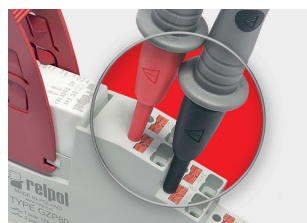

**Holes for test probes:** ergonomic, stable position of the probe in the socket, freedom to perform measurements and control.



**Space for label:** for self-adhesive paper, foil or polyester tapes (max. width 9 mm).

### Coil data - DC voltage version

Table 1

Coil code	Rated voltage V DC	Coil resistance at 20 °C Ω	Acceptable resistance	Coil operating range V DC ①	
				min. (at 20 °C)	max. (at 20 °C)
012DC	12	360	± 10%	8,4	30,6
<b>024DC</b>	<b>24</b>	<b>1 440</b>	<b>± 10%</b>	<b>16,8</b>	<b>61,2</b>
048DC	48	5 700	± 10%	33,6	122,4
110DC	110	25 200	± 10%	77,0	280,0

The data in bold type relate to the standard versions of the relays. ① The coil parameters are given for 20 °C and a relay with no load on the contacts. See details in Figure 5: permissible operating voltage range of the coil - DC voltage.

### Coil data - AC 50/60 Hz voltage version

Table 2

Coil code	Rated voltage V AC	Coil resistance at 20 °C Ω	Acceptable resistance	Coil operating range V AC 50 Hz	
				min. (at 20 °C)	max. (at 20 °C)
012AC	12	100	± 10%	9,6	13,2
<b>024AC</b>	<b>24</b>	<b>400</b>	<b>± 10%</b>	<b>19,2</b>	<b>28,8</b>
048AC	48	1 550	± 10%	38,4	57,6
115AC	115	9 600	± 10%	92,0	138,0
120AC	120	10 200	± 10%	96,0	144,0
<b>230AC</b>	<b>230</b>	<b>38 500</b>	<b>± 10%</b>	<b>184,0</b>	<b>276,0</b>

The data in bold type relate to the standard versions of the relays.

# PI85 with socket Push-in GZP80 interface relays with Push-in terminals

## Ordering codes

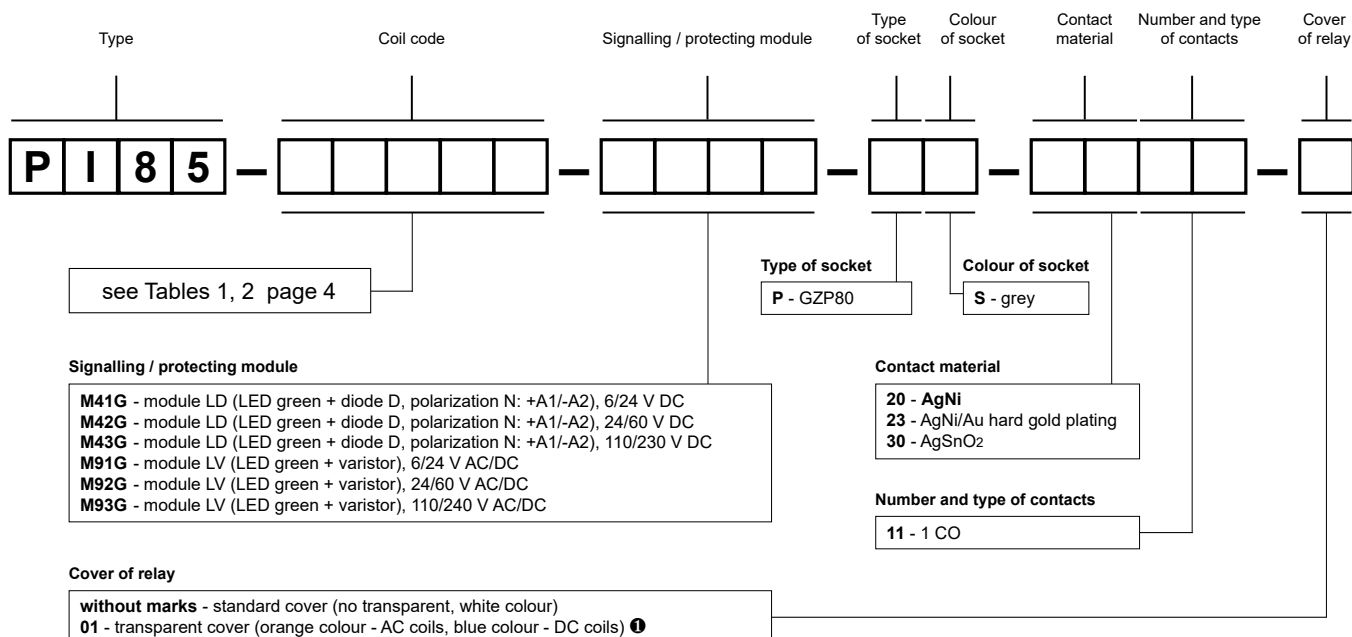

### Signalling / protecting module

**M41G** - module LD (LED green + diode D, polarization N: +A1/-A2), 6/24 V DC  
**M42G** - module LD (LED green + diode D, polarization N: +A1/-A2), 24/60 V DC  
**M43G** - module LD (LED green + diode D, polarization N: +A1/-A2), 110/230 V DC  
**M91G** - module LV (LED green + varistor), 6/24 V AC/DC  
**M92G** - module LV (LED green + varistor), 24/60 V AC/DC  
**M93G** - module LV (LED green + varistor), 110/240 V AC/DC

### Cover of relay

**without marks** - standard cover (no transparent, white colour)  
**01** - transparent cover (orange colour - AC coils, blue colour - DC coils) ①

① 01: special version - relay in transparent cover, operating temperature -20...+70 °C

Examples of ordering codes:

**PI85-230AC-M93G-PS-2011**

interface relay **PI85** consists of: relay **RM85** (white, one changeover contact, contact material AgNi, coil voltage 230 V AC 50/60 Hz), socket **GZP80** (grey, Push-in terminals), signalling / protecting module **M93G** (version LV), retainer / retractor clip **GZP80-0400** (red, plastic)

**PI85-024AC-M91G-PS-2311-01**

interface relay **PI85** consists of: relay **RM85** (orange, one changeover contact, contact material AgNi/Au hard gold plating, coil voltage 24 V AC 50/60 Hz), socket **GZP80** (grey, Push-in terminals), signalling / protecting module **M91G** (version LV), retainer / retractor clip **GZP80-0400** (red, plastic)

**PI85-024DC-M41G-PS-3011-01**

interface relay **PI85** consists of: relay **RM85** (blue, one changeover contact, contact material AgSnO<sub>2</sub>, coil voltage 24 V DC), socket **GZP80** (grey, Push-in terminals), signalling / protecting module **M41G** (version LD), retainer / retractor clip **GZP80-0400** (red, plastic)

**PI85-230AC-M93G-PS-2011**  
(standard white)

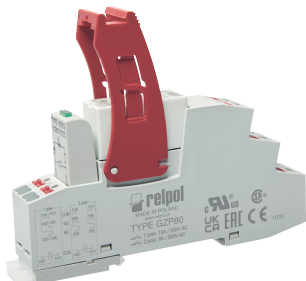

**PI85-024AC-M91G-PS-2311-01**  
(option transparent: AC orange)



**PI85-024DC-M41G-PS-2011-01**  
(option transparent: DC blue)



### PRECAUTIONS:

1. Ensure that the parameters of the product described in its specification provide a safety margin for the appropriate operation of the device or system and never use the product in circumstances which exceed the parameters of the product. 2. Never touch any live parts of the device. 3. Ensure that the product has been connected correctly. An incorrect connection may cause malfunction, excessive heating or risk of fire. 4. In case of any risk of any serious material loss or death or injuries of humans or animals, the devices or systems shall be designed so to equip them with double safety system to guarantee their reliable operation.



# Interconnection strips ZGZP... for sockets GZP80

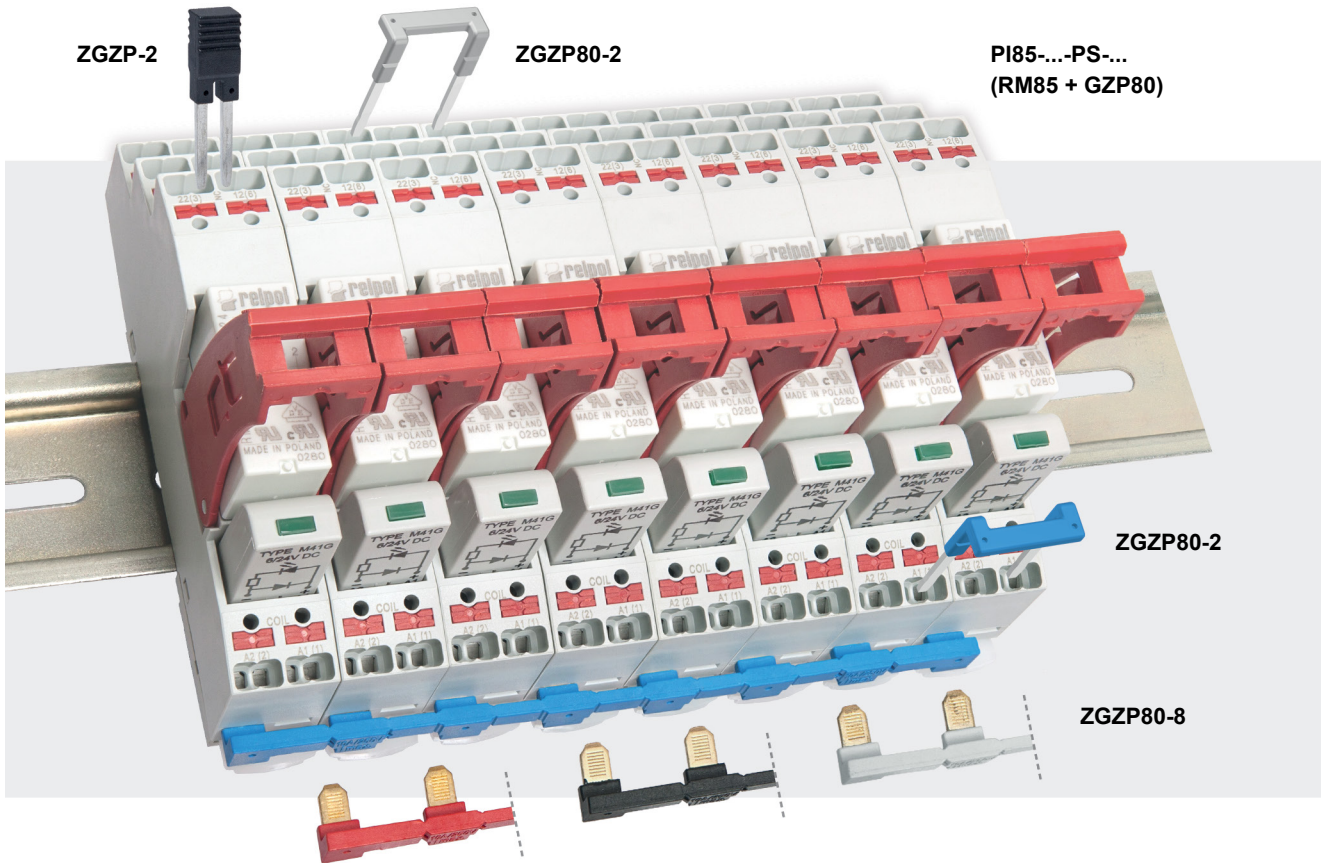

## ■ ZGZP... for:

Plug-in sockets	Relays for plug-in sockets	Interface relays ①
GZP80	RM84, RM85, RM85 inrush, RM85 105 °C sensitive, RM87L ②, RM87P ②, RMP84, RMP85	PI84-...-PS-... (RM84 + GZP80) PI85-...-PS-... (RM85 + GZP80) PI84P-...-PS-... (RMP84 + GZP80) PI85P-...-PS-... (RMP85 + GZP80)

① Interface relay **PI84** (**PI85**, **PI84P**, **PI85P**) is offered as a **set**: electromagnetic relay **RM84** (**RM85**, **RMP84**, **RMP85**) + plug-in socket **GZP80** + signalling / protecting module type **M...** + retainer / retractor clip **ZGZP80-0400**.  
② Also versions RM87. sensitive

## ■ Interconnection strips ZGZP...

- designed for the co-operation with plug-in sockets of miniature relays and with interface relays PI84, PI85, PI84P, PI85P, which are equipped with Push-in terminals; sockets and relays are mounted on 35 mm rail mount acc. to EN 60715,
- strip **ZGZP80-8** bridges common input signals (coil terminals A1 or A2), maximum permissible current is 10 A / 250 V AC, possibility of connection of 8 sockets or relays,



- strip **ZGZP80-2** bridges common input signals (coil terminals A1 or A2) or output signals, possibility of connection of 2+n sockets or relays,



- jumper **ZGZP-2** bridges the neighboring poles of single socket **GZP80** (usage of jumpers ZGZP-2 in interface relays Push-in PI85, PI85P increases load capacity of socket from 12 A to 16 A).

